

VOLVO EXCAVATOR

EC140B LC

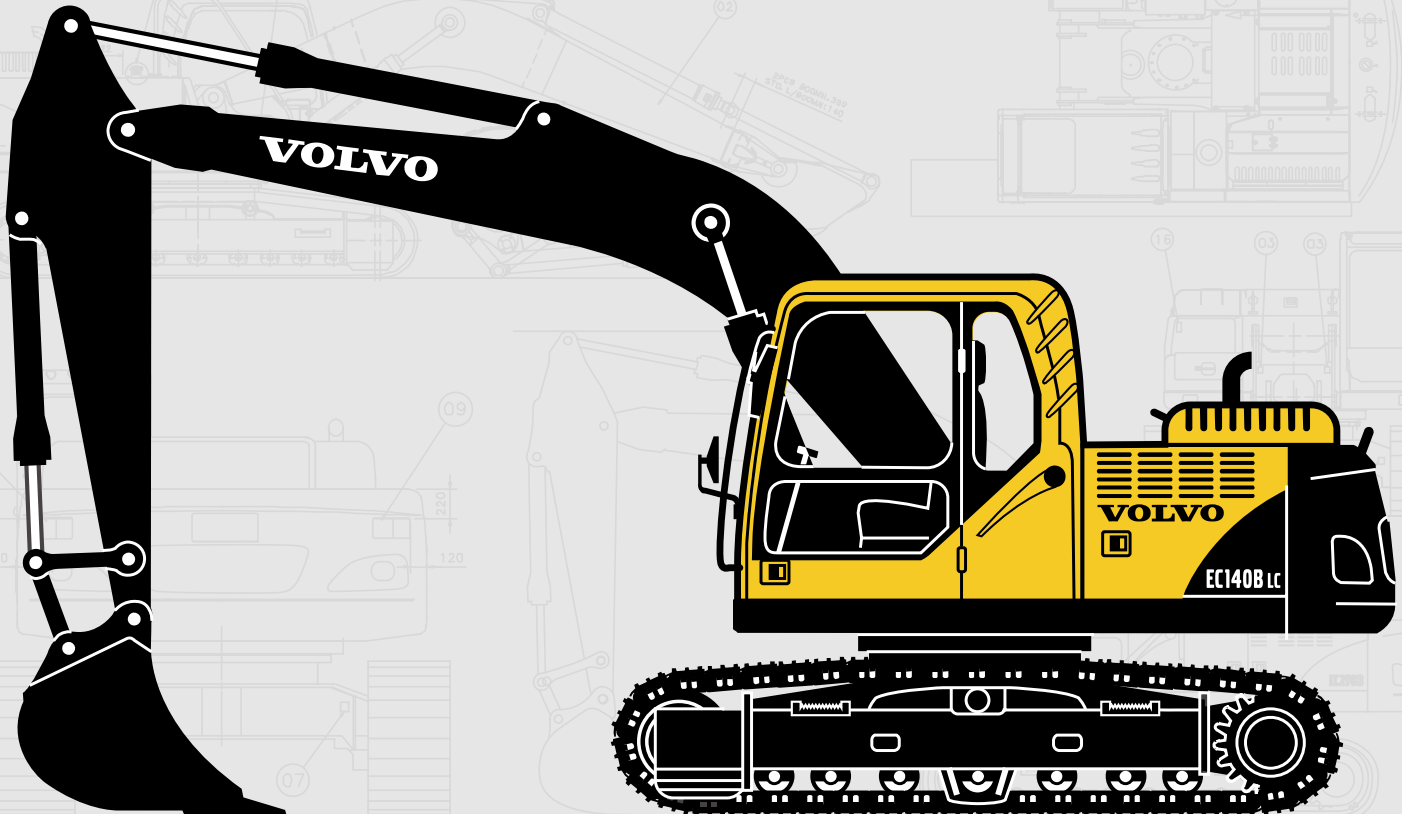

- Engine power, gross:
73 kW 98 hp
- Operating weight:
13.4 ~ 15.2 t
29,529 ~ 33,450 lb
- Buckets (SAE):
600 ~ 975 l
0.78 ~ 1.28 yd³
- Turbocharged Volvo diesel engine with direct injection meets EPA Tier 2 emission standards
- Contronics, Volvo's advanced mode selection system and electronically-controlled system
- 2 variable displacement axial piston pumps. Independent and simultaneous movements of the digging equipment are controlled by "Automatic Sensing Work Mode"
- Cab
 - Ergonomic environment for easier operator use
 - Low sound level
 - Filtered air
- Hydraulic dampening mounts
- Fabric seat with heater and air suspension
- Strong digging equipment produced by robotic welding
- High lifting, breakout and tearout forces for tough digging conditions
- Longer undercarriage for excellent stability
- Auxiliary hydraulic valve is standard
- Prepared for a number of optional items

VOLVO



ENGINE

The engine is a turbocharged, 4-stroke diesel engine with water cooling and direct injection that easily meets EPA Tier 2 emission standards. The engine has been developed especially for excavator use, providing good fuel economy, low noise levels and a long service life.

Air Filter: 3-stage

Automatic Idling System: Reduces engine speed to idle when the levers and pedals are not activated resulting in less fuel consumption and low cab noise levels.

Low-Emission Engine:

Make	VOLVO
Model	D4D EAE2
Power output at	35 r/s 2,100 rpm
Net (ISO 9249/ SAE J1349)	69 kW 93 hp
Gross (SAE J1995)	73 kW 98 hp
Max. torque	390 N·m at 1,500 rpm 288 lb·ft at 1,500 rpm
No. of cylinders	4
Displacement	4 l 244 cu.in
Bore	101 mm 3.98"
Stroke	126 mm 4.96"



ELECTRICAL SYSTEM

High-capacity electrical system that is well protected. Waterproof double-lock harness plugs are used to secure corrosion-free connections. The main relays and solenoid valves are shielded to prevent damage. The master switch is standard.

Contronics provides advanced monitoring of machine functions and important diagnostic information.

Voltage	24 V
Batteries	2 x 12 V
Battery capacity	100 Ah
Alternator	28 V / 80 A



SERVICE REFILL CAPACITIES

Fuel tank	260 l	68.7 gal
Hydraulic system, total	205 l	54.2 gal
Hydraulic tank	100 l	26.4 gal
Engine oil	15.5 l	4.1 gal
Engine coolant	20.3 l	5.4 gal
Swing reduction unit	3.8 l	1.0 gal
Travel reduction unit	2 x 3.5 l	2 x 0.9 gal



SWING SYSTEM

The superstructure is swung by the means of an axial piston motor and a planetary reduction gear. Automatic swing holding brake and anti-rebound valve are standard.

Max. swing speed 11.0 rpm



DRIVE

Each track is powered by an automatic two-speed shift travel motor. The track brakes are multi-disc, spring-applied and hydraulic released. The travel motor, brake and planetary gears are well protected within the track frame.

Max. drawbar pull (tractive effort)	109.8 kN 24,700 lb
Max. travel speed	3.2/5.5 km/h 2.0/3.4 mph
Gradeability	35° 70%



UNDERCARRIAGE









The undercarriage has a robust X-shaped frame. Greased and sealed track chains are standard.

No. of track pads	2 x 46
Link pitch	171.45 mm 6.75"
Shoe width, triple grouser	500/600(Std.)/700/750 mm 20"/24"(Std.)/28"/30"
No. of bottom track rollers	2 x 7
No. of top rollers	2 x 1

LIFTING CAPACITY (At the arm end without bucket)

Note: For lifting capacity including bucket, simply subtract actual weight of the pin-on bucket or the bucket with quick coupler from the following values.

EC140B LC (Std. shoe 600 mm, 24")

 Across under-carriage  Along under-carriage	Lifting hook related to ground level	1.5 m, 5'		3.0 m, 10'		4.5 m, 15'		6.0 m, 20'		Max. reach											
																Max. m / ft					
		t	lb	t	lb	t	lb	t	lb	t	lb	t	lb	t	lb						
with CWT 2,100 kg, 4,630 lb Std. boom 4.6 m, 15' 1" + Arm 2.1 m, 6' 11"	6.0 20'																				
	4.5 15'																				
	3.0 10'																				
	1.5 5'																				
	0 0'																				
	-1.5 -5'	*4.8	*10,830	*4.8	*10,830	*9.5	*20,520	5.6	12,130	5.0	10,730	3.1	6,620					3.3	7,280	2.1	4,640
-3.0 -10'					*8.2	*17,770	5.8	12,400	5.1	10,920	3.1	6,780					4.5	9,990	2.8	6,270	4.9 / 15.9
with CWT 2,100 kg, 4,630 lb Std. boom 4.6 m, 15' 1" + Std. Arm 2.5 m, 8' 2"	6.0 20'																				
	4.5 15'																				
	3.0 10'																				
	1.5 5'																				
	0 0'																				
	-1.5 -5'	*4.4	*9,900	*4.4	*9,900	*9.3	*20,780	5.5	11,900	4.9	10,600	3.0	6,490	3.2	6,930	2.0	4,380	2.9	6,510	1.9	4,130
-3.0 -10'	*8.6	*19,460	*8.6	*19,460	*8.7	*18,730	5.6	12,110	5.0	10,710	3.1	6,580					3.8	8,460	2.4	5,320	5.4 / 17.6
with CWT 2,100 kg, 4,630 lb Std. boom 4.6 m, 15' 1" + Arm 3.0 m, 9' 10"	6.0 20'																				
	4.5 15'																				
	3.0 10'																				
	1.5 5'																				
	0 0'																				
	-1.5 -5'	*3.8	*8,560	*3.8	*8,560	*8.4	*19,260	5.4	11,680	4.9	10,460	3.0	6,350	3.2	6,800	2.0	4,250	2.6	5,680	1.6	3,570
-3.0 -10'	*7.0	*15,920	*7.0	*15,920	*9.1	*19,580	5.5	11,800	4.9	10,490	3.0	6,370					3.2	7,030	2.0	4,410	6.0 / 19.7
with CWT 2,450 kg, 5,400 lb Std. boom 4.6 m, 15' 1" + Arm 2.1 m, 6' 11"	6.0 20'																				
	4.5 15'																				
	3.0 10'																				
	1.5 5'																				
	0 0'																				
	-1.5 -5'	*4.8	*10,830	*4.8	*10,830	*9.5	*20,520	6.0	12,980	5.3	11,360	3.3	7,100					3.5	7,710	2.3	4,980
-3.0 -10'					*8.2	*17,770	6.2	13,250	5.4	11,550	3.4	7,260					4.7	10,570	3.0	6,720	4.9 / 15.9
with CWT 2,450 kg, 5,400 lb Std. boom 4.6 m, 15' 1" + Std. Arm 2.5 m, 8' 2"	6.0 20'																				
	4.5 15'																				
	3.0 10'																				
	1.5 5'																				
	0 0'																				
	-1.5 -5'	*4.4	*9,900	*4.4	*9,900	*9.3	*20,780	5.9	12,750	5.2	11,230	3.2	6,970	3.4	7,350	2.2	4,720	3.1	6,900	2.0	4,450
-3.0 -10'	*8.6	*19,460	*8.6	*19,460	*8.7	*18,730	6.0	12,970	5.3	11,340	3.3	7,060					4.0	8,970	2.6	5,720	5.4 / 17.6
with CWT 2,450 kg, 5,400 lb Std. boom 4.6 m, 15' 1" + Arm 3.0 m, 9' 10"	6.0 20'																				
	4.5 15'																				
	3.0 10'																				
	1.5 5'																				
	0 0'																				
	-1.5 -5'	*3.8	*8,560	*3.8	*8,560	*8.4	*19,260	5.8	12,530	5.2	11,100	3.2	6,840	3.4	7,220	2.1	4,580	2.7	6,040	1.8	3,860
-3.0 -10'	*7.0	*15,920	*7.0	*15,920	*9.1	*19,580	5.9	12,650	5.2	11,120	3.2	6,850					3.4	7,460	2.1	4,750	6.0 / 19.7

- Notes:
- Machine in "Fine Mode-F" (Power Boost) for lifting capacities.
 - The above loads are in compliance with SAE J1097 and ISO 10567 Hydraulic Excavator Lifting Capacity Standards.
 - Rated loads do not exceed 87% of hydraulic lifting capacity or 75% of tipping load.
 - Rated loads marked with an asterisk (*) are limited by hydraulic capacity rather than tipping load.
 - Contains metric and U.S. measurement charts.

DIMENSIONS

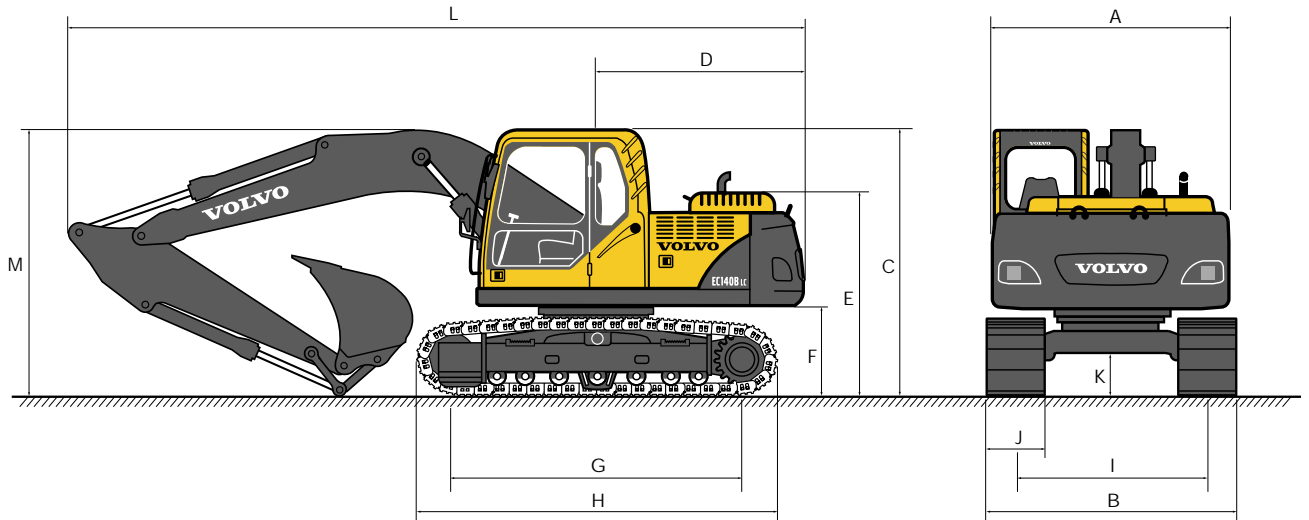

Boom	Unit	Std. 4.6 m, 15' 1"		
Arm		2.1 m, 6' 11"	Std. 2.5 m, 8' 2"	3.0 m, 9' 10"
A. Overall width of superstructure	mm, ft-in	2,450, 8' 0"	2,450, 8' 0"	2,450, 8' 0"
B. Overall width	mm, ft-in	2,590, 8' 6"	2,590, 8' 6"	2,590, 8' 6"
C. Overall height of cab	mm, ft-in	2,770, 9' 1"	2,770, 9' 1"	2,770, 9' 1"
D. Tail swing radius	mm, ft-in	2,130, 7' 0"	2,130, 7' 0"	2,130, 7' 0"
E. Overall height of engine hood	mm, ft-in	2,080, 6' 10"	2,080, 6' 10"	2,080, 6' 10"
F. Counterweight clearance *	mm, ft-in	900, 2' 11"	900, 2' 11"	900, 2' 11"
G. Tumbler length	mm, ft-in	3,000, 9' 10"	3,000, 9' 10"	3,000, 9' 10"
H. Track length	mm, ft-in	3,740, 12' 3"	3,740, 12' 3"	3,740, 12' 3"
I. Track gauge	mm, ft-in	1,990, 6' 6"	1,990, 6' 6"	1,990, 6' 6"
J. Shoe width	mm, in	600, 24"	600, 24"	600, 24"
K. Min. ground clearance *	mm, ft-in	430, 1' 5"	430, 1' 5"	430, 1' 5"
L. Overall length	mm, ft-in	7,610, 25' 0"	7,550, 24' 9"	7,320, 24' 0"
M. Overall height of boom	mm, ft-in	2,710, 8' 11"	2,830, 9' 3"	3,210, 10' 6"

* Without shoe grouser

WORKING RANGES & DIGGING FORCES

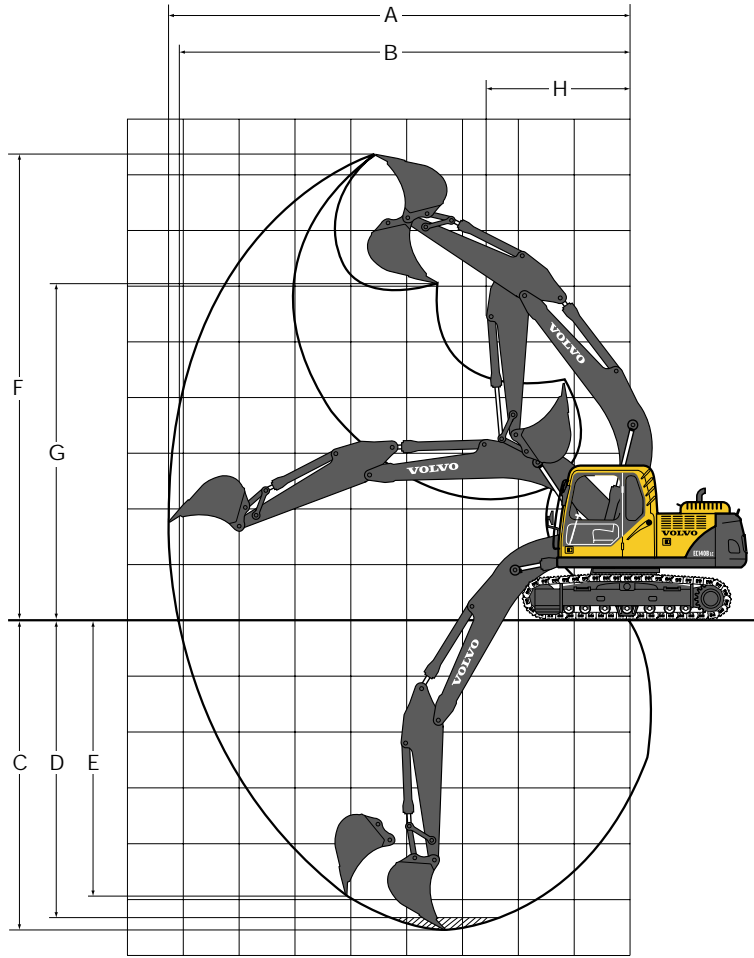

• Machine with pin-on bucket

Boom	Unit	Std. 4.6 m, 15' 1"		
Arm		2.1 m, 6' 11"	Std. 2.5 m, 8' 2"	3.0 m, 9' 10"
A. Max. digging reach	mm, ft-in	7,960, 26' 1"	8,330, 27' 4"	8,820, 28' 11"
B. Max. digging reach on ground	mm, ft-in	7,810, 25' 7"	8,190, 26' 10"	8,690, 28' 6"
C. Max. digging depth	mm, ft-in	5,130, 16' 10"	5,530, 18' 2"	6,030, 19' 9"
D. Max. digging depth (8' level)	mm, ft-in	4,870, 16' 0"	5,310, 17' 5"	5,850, 19' 2"
E. Max. vertical wall digging depth	mm, ft-in	4,580, 15' 0"	5,060, 16' 7"	5,500, 18' 1"
F. Max. cutting height	mm, ft-in	8,180, 26' 10"	8,420, 27' 7"	8,770, 28' 9"
G. Max. dumping height	mm, ft-in	5,740, 18' 10"	5,980, 19' 7"	6,320, 20' 9"
H. Min. front swing radius	mm, ft-in	2,570, 8' 5"	2,630, 8' 8"	2,840, 9' 4"

• Digging forces with pin-on bucket

Boom	Unit	Std. 4.6 m, 15' 1"		
Arm		2.1 m, 6' 11"	Std. 2.5 m, 8' 2"	3.0 m, 9' 10"
Bucket tip radius	mm, in	1,250, 49"	1,250, 49"	1,250, 49"
Breakout force – bucket (Normal/Power boost)	SAE kN lb	82.4/87.3 18,520/19,620	82.4/87.3 18,520/19,620	82.4/87.3 18,520/19,620
Teaout force – arm (Normal/Power boost)	SAE kN lb	69.6/73.5 15,660/16,540	61.8/65.7 13,890/14,770	54.9/58.8 12,350/13,230
Rotation angle, bucket	deg	174°	174°	173°



HYDRAULIC SYSTEM

The hydraulic system, also known as the “Automatic Sensing Work Mode,” is designed for high-productivity, high-digging capacity, high-maneuvering precision and good fuel economy. The summation system, boom, arm and swing priority along with boom and arm regeneration provides optimum performance.

The following important functions are included in the system:

Summation system: Combines the flow of both hydraulic pumps to ensure quick cycle times and high productivity.

Boom priority: Gives priority to the boom operation for faster raising when loading or performing deep excavations.

Arm priority: Gives priority to the arm operation for faster cycle times in leveling and for increased bucket filling when digging.

Swing priority: Gives priority to swing functions for faster simultaneous operations.

Regeneration system: Prevents cavitation and provides flow to other movements during simultaneous operations for maximum productivity.

Power boost: All digging and lifting forces are increased.

Holding valves: Boom and arm holding valves prevent the digging equipment from creeping.

Main pump:

Type 2 x variable displacement axial piston pumps
Maximum flow . . . 2 x 118 l/min **2 x 31 gpm**

Pilot pump:

Type Gear pump
Maximum flow . . . 1 x 21 l/min **5.5 gpm**

Hydraulic motors:

Travel Variable displacement axial piston motors
Swing Fixed displacement axial piston motor with mechanical brake

Relief valve setting:

Implement 32.4/34.3 Mpa **4,690/4,980 psi**
Travel circuit 34.3 Mpa **4,980 psi**
Swing circuit 24.5 Mpa **3,560 psi**
Pilot circuit 3.9 Mpa **570 psi**

Hydraulic cylinders:

Boom 2
Bore x Stroke \varnothing 105 x 980 mm
 \varnothing 4.1" x 38.6"
Arm 1
Bore x Stroke \varnothing 120 x 1,045 mm
 \varnothing 4.7" x 41.1"
Bucket 1
Bore x Stroke \varnothing 100 x 865 mm
 \varnothing 3.9" x 34.1"



CAB

The operator's cab has easy access via a wide door opening. The cab is supported on hydraulic dampening mounts to reduce shock and vibration levels. These along with sound absorbing lining provide low noise levels. The cab has excellent all-round visibility. The front windshield can easily slide up into the ceiling, and the lower front glass can be removed and stored in the side door.

Integrated air-conditioning and heating system:

The pressurized and filtered cab air is supplied by an automatically-controlled fan. The air is distributed throughout the cab from 13 vents.

Ergonomic operator's seat: The adjustable seat and joystick console move independently to accommodate the operator. The seat has nine different adjustments plus a seat belt for the operator's comfort and safety.

Sound Level:

Sound level in cab
according to ISO 6396 LpA 72 dB(A)
External sound level
according to ISO 6395
and EU Directive 2000/14/EC LwA 100 dB(A)



GROUND PRESSURE

- LC undercarriage with Std. 4.6 m, 15' 1" boom, Std. 2.5 m, 8' 2" arm, 400 kg, 880 lb bucket and 2,100 kg, 4,630 lb counterweight

Description	Shoe width	Operating weight	Ground pressure	Overall width
Triple grouser	500 mm 20"	13,390 kg 29,520 lb	40.3 kPa 5.9 psi	2,490 mm 8' 2"
	Std. 600 mm 24"	13,600 kg 29,990 lb	34.1 kPa 5.0 psi	2,590 mm 8' 6"
	700 mm 28"	13,810 kg 30,450 lb	29.7 kPa 4.3 psi	2,690 mm 8' 10"
	750 mm 30"	13,920 kg 30,690 lb	28.0 kPa 4.1 psi	2,740 mm 9' 0"

- LC undercarriage with Std. 4.6 m, 15' 1" boom, Std. 2.5 m, 8' 2" arm, 400 kg, 880 lb bucket and 2,450 kg, 5,400 lb counterweight

Description	Shoe width	Operating weight	Ground pressure	Overall width
Triple grouser	500 mm 20"	13,740 kg 30,300 lb	41.4 kPa 6.0 psi	2,490 mm 8' 2"
	Std. 600 mm 24"	13,950 kg 30,760 lb	35.0 kPa 5.1 psi	2,590 mm 8' 6"
	700 mm 28"	14,160 kg 31,220 lb	30.5 kPa 4.4 psi	2,690 mm 8' 10"
	750 mm 30"	14,270 kg 31,470 lb	28.7 kPa 4.2 psi	2,740 mm 9' 0"

- LC undercarriage dozer blade with Std. 4.6 m, 15' 1" boom, Std. 2.5 m, 8' 2" arm, 400 kg, 880 lb bucket and 2,100 kg, 4,630 lb counterweight

Description	Shoe width	Operating weight	Ground pressure	Overall width
Triple grouser	500 mm 20"	14,290 kg 31,510 lb	43.0 kPa 6.2 psi	2,490 mm 8' 2"
	Std. 600 mm 24"	14,500 kg 31,970 lb	36.4 kPa 5.3 psi	2,590 mm 8' 6"
	700 mm 28"	14,710 kg 32,440 lb	31.6 kPa 4.6 psi	2,690 mm 8' 10"
	750 mm 30"	14,820 kg 32,680 lb	29.8 kPa 4.3 psi	2,740 mm 9' 0"

- LC undercarriage dozer blade with Std. 4.6 m, 15' 1" boom, Std. 2.5 m, 8' 2" arm, 400 kg, 880 lb bucket and 2,450 kg, 5,400 lb counterweight

Description	Shoe width	Operating weight	Ground pressure	Overall width
Triple grouser	500 mm 20"	14,640 kg 32,280 lb	44.1 kPa 6.4 psi	2,490 mm 8' 2"
	Std. 600 mm 24"	14,850 kg 32,740 lb	37.3 kPa 5.4 psi	2,590 mm 8' 6"
	700 mm 28"	15,060 kg 33,210 lb	32.4 kPa 4.7 psi	2,690 mm 8' 10"
	750 mm 30"	15,170 kg 33,450 lb	30.5 kPa 4.4 psi	2,740 mm 9' 0"

MAX. PERMITTED BUCKETS

Note: 1. Bucket size based on ISO 7451, heaped material with a 1:1 angle of repose.
 2. "Max. permitted sizes" are for reference only and are not necessarily available from the factory.

● LC undercarriage, max. permitted sizes for pin-on buckets: Counterweight 2,100 kg, 4,630 lb

Boom	Unit	Std. 4.6 m, 15' 1"		
Arm		2.1 m, 6' 11"	Std. 2.5 m, 8' 2"	3.0 m, 9' 10"
GP bucket 1.5 t/m ³ , 2,530 lb/yd ³	l, yd ³	925, 1.21	825, 1.08	725, 0.95
GP bucket 1.8 t/m ³ , 3,030 lb/yd ³	l, yd ³	800, 1.05	725, 0.95	650, 0.85

● LC undercarriage, max. permitted sizes for hook-on buckets: Counterweight 2,100 kg, 4,630 lb

Boom	Unit	Std. 4.6 m, 15' 1"		
Arm		2.1 m, 6' 11"	Std. 2.5 m, 8' 2"	3.0 m, 9' 10"
GP bucket 1.5 t/m ³ , 2,530 lb/yd ³	l, yd ³	875, 1.14	800, 1.05	700, 0.92
GP bucket 1.8 t/m ³ , 3,030 lb/yd ³	l, yd ³	775, 1.01	700, 0.92	600, 0.78

● LC undercarriage, max. permitted sizes for pin-on buckets: Counterweight 2,450 kg, 5,400 lb

Boom	Unit	Std. 4.6 m, 15' 1"		
Arm		2.1 m, 6' 11"	Std. 2.5 m, 8' 2"	3.0 m, 9' 10"
GP bucket 1.5 t/m ³ , 2,530 lb/yd ³	l, yd ³	975, 1.28	900, 1.18	800, 1.05
GP bucket 1.8 t/m ³ , 3,030 lb/yd ³	l, yd ³	850, 1.11	775, 1.01	700, 0.92

● LC undercarriage, max. permitted sizes for hook-on buckets: Counterweight 2,450 kg, 5,400 lb

Boom	Unit	Std. 4.6 m, 15' 1"		
Arm		2.1 m, 6' 11"	Std. 2.5 m, 8' 2"	3.0 m, 9' 10"
GP bucket 1.5 t/m ³ , 2,530 lb/yd ³	l, yd ³	950, 1.24	850, 1.11	750, 0.98
GP bucket 1.8 t/m ³ , 3,030 lb/yd ³	l, yd ³	825, 1.08	750, 0.98	650, 0.85

DIMENSIONS

• Boom

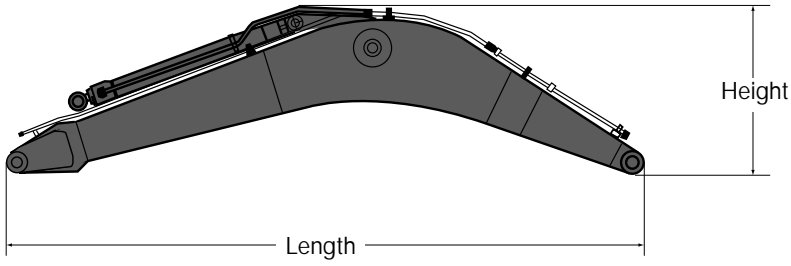

Description	4.6 m, 15' 1"
Length	4,770 mm, 15' 8"
Height	1,370 mm, 4' 6"
Width	545 mm, 1' 9"
Weight	1,000 kg, 2,210 lb

* Includes cylinder, pin and piping

• Arm

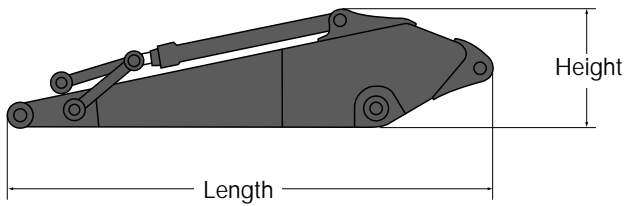

Description	2.1m, 6' 11"	Std. 2.5 m, 8' 2"	3.0 m, 9' 10"
Length	2,800 mm, 9' 2"	3,190 mm, 10' 6"	3,690 mm, 12' 1"
Height	760 mm, 2' 6"	760 mm, 2' 6"	760 mm, 2' 6"
Width	300 mm, 1' 0"	300 mm, 1' 0"	300 mm, 1' 0"
Weight	570 kg, 1,260 lb	645 kg, 1,420 lb	720 kg, 1,590 lb

* Includes cylinder, piping and linkage

• Front dozer blade

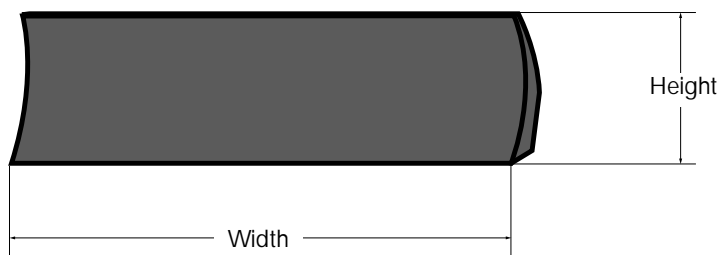

Description	Measurement
Height	580 mm, 1' 11"
Width	2,590 mm, 8' 6"
Weight	900 kg, 1,980 lb
Digging depth	562 mm, 1' 10"
Lift height	504 mm, 1' 8"

STANDARD EQUIPMENT

Engine

Turbocharged, 4-stroke diesel engine with water cooling, and direct injection that meets EPA (Environment Protection Agency) Tier 2 emission standards
3-stage air filter with indicator
Air intake heater
Electric engine shut-off
Fuel filter and water separator
Coolant filter
Alternator, 80 A

Electric/Electronic control system

Contronics
– Advanced mode control system
– Self-diagnostic system
Machine status indication
Engine speed sensing power control
Automatic idling system
One-touch power boost
Safety stop/start function
Travel alarm
Adjustable monitor
Master switch
Engine restart prevention circuit

High-capacity halogen lights:
– Frame-mounted 2
– Boom-mounted 2
Batteries, 2 x 12 V / 100 Ah
Start motor, 24 V / 4.8 kW

Hydraulic system

Automatic hydraulic system
– Summation system
– Boom priority
– Arm priority
– Swing priority
Hydraulic piping
– Hammer & shear:
1 pump flow
– Quick coupler piping
Boom and arm regeneration valves
Swing anti-rebound valves
Boom and arm holding valves
Pump flow control for hammer & shear
Multi-stage filtering system
Cylinder cushioning
Cylinder contamination seals
Auxiliary hydraulic valve
Straight travel circuit
Automatic two-speed travel motors
Hydraulic oil, ISO VG 46

Superstructure

Access way with handrail
Full height counterweight
2,100 kg, 4,630 lb
Tool storage area
Punched metal anti-slip plates
Undercover (heavy-duty 4,5 mm, 0.18")

Cab and interior

Fabric seat with heater and air suspension
Pilot-operated wrist control joysticks with 3 switches each
Heater & air-conditioner, automatic
Hydraulic dampening cab mounts
Adjustable operator seat and joystick control console
Flexible antenna
Hydraulic safety lock lever
Cab, all-weather sound suppressed, includes:
– Ashtray
– Cup holder
– Lighter
– Tinted glass
– Door locks
– Floor mat

– Horn
– Large storage area
– Pull-up type front window
– Removable lower windshield
– Seat belt
– Safety glass
– Sun shield, front, roof, rear
– Windshield wiper with intermittent feature
– Stereo cassette radio
Anti-vandalism kit assembly preparation
Master ignition key

Undercarriage

Hydraulic track adjusters
Greased and sealed track chain
Track guards
Undercover (4,5 mm, 0.18")

Track shoes

Track shoes 600 mm, 24" with triple grousers

Digging equipment

Boom: 4.6 m, 15' 1"
Arm: 2.5 m, 8' 2"

OPTIONAL EQUIPMENT *(Standard in certain markets)*

Engine

Block heater: 120 V
Diesel coolant heater
Tropical cooling kit
Fuel filler pump: 50 l/min, 13.2 gpm with automatic shut-off

Electric

Extra lamps:
– Cab-mounted 3 (front 2, rear 1)
– Counterweight-mounted 1
Overload warning device
Rotating warning beacon

Hydraulic system

Hose rupture valve: boom, arm
Hydraulic piping
– Hammer & shear:
2 pump flow
Additional return filter
Extra piping for slope & rotator
– Slope & rotator
– Grapple
– Oil leak (drain) line
Volvo hydraulic quick-coupler, S6 size
Hydraulic oil, ISO VG 32
Hydraulic oil, ISO VG 68
Hydraulic oil, biodegradable 32
Hydraulic oil, biodegradable 46

Superstructure

Full height counterweight
2,450 kg, 5,400 lb

Cab and interior

Fabric seat
Fabric seat with heater
Control joystick with semi-long levers
Control joystick with 5 switches each
Pilot control pattern change
Air-conditioner, manual
Falling object guard (FOG)
Cab-mounted falling object protective structures (FOPS)
Sunlight protection, roof (steel)
Rain shield, front
Safety screen for front window
Lower wiper
Anti-vandalism kit

Track shoes

500 mm, 20"/700 mm, 28"/
750 mm, 30" track shoes

Undercarriage

Front dozer blade
Undercover (heavy-duty 10 mm, 0.39")

Digging equipment

Arm: 2.1 m, 6' 11"
3.0 m, 9' 10"

Service

Hand lamp
Spare parts
Tool kit, full scale

All products are not available in all markets. Under our policy of continuous improvement, we reserve the right to change specifications and designs without prior notice. The illustrations do not necessarily show the standard version of the machine.

VOLVO

Volvo Construction Equipment
North America, Inc.

One Volvo Drive, Asheville, NC 28803-3447
www.volvoce.com

Ref. No. 22 3 435 1640 English
Printed in USA 09/04 – 5.0 GMC
Volvo, Asheville